

**Contract Details**

1A. Special item numbers: 711-11, 711-16, 711-18, 711-19, 711-2, 71-302

1B. Lowest Priced Item  
 1B. Lowest Priced Item  
 Catalog #: B03169 (711-16) Net Price: \$207.41  
 Catalog #: SW9840 (711-18) Net Price: \$178.08  
 Catalog #: ED4000 (711-19) Net Price: \$100.14  
 Catalog #: MZ7001 (71-302) Net Price: \$282.83  
 Catalog #: KT4C30 (711-2) Net Price: \$230.00  
 Catalog #: DP/RW00036C (711-11) Net Price: \$540.00  
 Catalog #: SW9820 (711-18) Net Price: \$196.51

2. Maximum Order Limitation: \$50,000  
 3. Minimum Order: \$50.00  
 4. Geographical Coverage: 50 United States  
 5. Point of Production: Boonton, NJ  
 Etovicoke, Ontario

6. Discount: Net Prices Shown  
 7. Quantity Discounts: NA

8. Prompt Payment Terms: Standard net 30 days  
 9A. Government Commercial Credit Card: YES  
 9B. Discount for Commercial Government Credit Card: NONE  
 10. Foreign Item: NO  
 11. Time of Delivery: 90 days ARO  
 12. F.O.B. Point: Destination  
 Fuel Surcharge: 3% of GSA Net  
 13. Ordering Address: Dauphin North America  
 c/o Your Participating Dealer  
 300 Myrtle Avenue  
 Boonton, NJ 07005

14. Payment Address: Dauphin North America  
 300 Myrtle Avenue  
 Boonton, NJ 07005

15. Warranty Provision: Standard Lifetime Warranty

16. Export Packing Charges: NA  
 17. Terms and Conditions of Government Commercial Credit Card acceptance: NA  
 18. Terms/conditions of rentals/maintenance/repair: NA  
 19. Terms/conditions of Installation: NA  
 20. Terms/conditions of repair parts, etc: NA  
 21. List of service and distribution points: NA  
 22. List of participating dealers: Call 1-800-631-1186  
 23. Preventative maintenance: NA  
 24. Environmental Attributes: Contact Dauphin  
 931524086  
 25. DUNS Number  
 26. CCR Registration: Active, Cage Code# 01TP2

Order Changes  
 Our acknowledgment of accepted order takes precedence over buyer's purchase order. Any error or discrepancy on acknowledgment must be reported to Dauphin in writing within three (3) working days of acknowledgment date. Changes to order at customer's request may result in additional charges based on costs incurred by Dauphin. Once production has started, changes will not be accepted.

Restocking terms: The restocking charge will not exceed 20% of the net cost for items returned for other than warranty reasons. Agencies must notify contractor for authorization prior to returning items.

Cancellation Policy: No cost prior to production. After production has begun, only actual costs incurred will be billed to customer if merchandise cannot be resold within a reasonable length of time (6 months).

Lifetime Warranty: Dauphin North America warrants its Dauphin seating products to be free from defects in material and workmanship for as long as the original customer owns and uses the product under normal, single-shift office conditions. If a product is defective, and if written notice of the defect is given to Dauphin North America within the applicable warranty period, Dauphin at its option will either repair or replace the defective part or product with a comparable component or product. The Lifetime

Warranty applies to all products, except as noted below:

Warranty	Period
Seating Mechanism	10 Years
Stacking and side chairs	10 Years
Foam, Dauphin fabrics and other upholstery materials	3 Years
Moving parts, such as backrest cylinders and adjustable arms	5 Years

This warranty does not apply to defects from normal wear and tear, accidents, negligence, abuse, shipment, handling, storage, or environmental conditions, nor does it apply to "Customer's Own Materials". Any modifications to our products made by the purchaser, purchaser's employees or agents, voids this warranty.

This warranty extends to all products shipped after August 1, 1994 which are used for normal office purposes and single shift service. All claims under this warranty must be made by the original purchaser within 30 days of alleged defect.

This warranty is the customer's sole remedy for product defect. No other expressed or implied warranty is provided. Dauphin North America is not responsible for any consequential, economic or incidental damages arising from any product defect.

FSC Group: 71, Part I, Office Furniture  
 Contract #: GS-28F-1119C  
 Federal I.D. #: 22-3258679  
 Contract Period: 7/26/2011 through 7/27/2015  
 Small Business

**GSA Contract Terms & Conditions**

May 1, 2011

General Services Administration  
 Federal Acquisition Service

Authorized Federal Supply Schedule Price List  
 Schedule 71-Furniture



Contract Detail: No. GS-28F-1119C  
 July 26, 2011 - July 27, 2015

**working**

Pages

Work Tables	4-6
Penninsulas	6
L>Returns	6
Corner Tables & Corner Links	7
120 Tables	8
Modesty Panels	8
Storage	9
Acrylic Screens	10
System Screens	11
Insert Screens	12











**training & meeting**

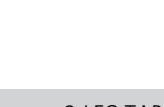
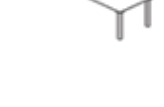







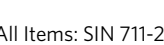

Training Tables	13 - 14
Conference Tables	15
Round Tables	16
Square Tables	16
Race Track Shaped Tables	16
Bullet Shaped Tables	16
Extend-a-Table Leaf Extensions	17
Configurations	18















**accessories & finishes**





Lighting	19
Slat Wall Accessories	19
Screen Shelves	20
Table Connectors	20
Electrical	21-22
Nesting Tables	24
Finishes-Laminates	25-24
Finishes-Metal	25
Finished- Screen Fabrics	25
Terms & Conditions	26









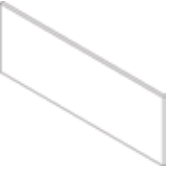
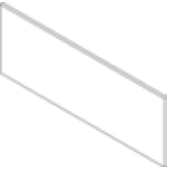







Product	Size L x D x H	Model #	Description	Quick Ship Laminates	Standard Laminates	Dauphin Laminates
<b>4-LEG TABLE</b>						
	72 x 30 x 29	K-TB4-7230	High Pressure laminate with equal balanced backer on 1/8" superior grade CARB particle board with 3 mm PVC edging: 4 KAPs, 4 legs, 2 grommets.	\$306.71	\$306.71	\$368.30
	66 x 30 x 29	K-TB4-6630		\$303.78	\$364.53	
	60 x 30 x 29	K-TB4-6030		\$283.24	\$339.81	
	48 x 30 x 29	K-TB4-4830		\$261.04	\$312.99	
	42 x 30 x 29	K-TB4-4230		\$258.52	\$310.06	
	36 x 30 x 29	K-TB4-3630		\$243.44	\$292.04	
	30 x 30 x 29	K-TB4-3030	High Pressure laminate with equal balanced backer on 1/8" superior grade CARB particle board with 3 mm PVC edging: 4 KAPs, 4 legs, no grommets		\$234.64	\$281.57
	24 x 30 x 29	K-TB4-2430		\$218.72	\$262.29	
	72 x 24 x 29	K-TB4-7224	High Pressure laminate with equal balanced backer on 1/8" superior grade CARB particle board with 3 mm PVC edging: 4 KAPs, 4 legs, 2 grommets	\$277.80	\$277.80	\$333.11
	66 x 24 x 29	K-TB4-6624		\$276.12	\$331.43	
	60 x 24 x 29	K-TB4-6024		\$258.52	\$310.06	
	48 x 24 x 29	K-TB4-4824		\$241.76	\$290.37	
	42 x 24 x 29	K-TB4-4224		\$238.83	\$286.60	
	36 x 24 x 29	K-TB4-3624		\$227.10	\$272.77	
	30 x 24 x 29	K-TB4-3024	High Pressure laminate with equal balanced backer on 1/8" superior grade CARB particle board with 3 mm PVC edging: 4 KAPs, 4 legs, no grommets		\$218.72	\$262.29
	24 x 24 x 29	K-TB4-2424		\$209.92	\$251.82	
<b>2-LEG TABLE</b>						
(for connecting tables)						
	72 x 30 x 29	K-TB2-7230	High Pressure laminate with equal balanced backer on 1/8" superior grade CARB particle board with 3 mm PVC edging: 4 KAPs, 2 legs, 2 grommets Includes table connectors	\$281.15	\$281.15	\$337.30
	66 x 30 x 29	K-TB2-6630		\$277.80	\$333.52	
	60 x 30 x 29	K-TB2-6030		\$257.27	\$3080	
	48 x 30 x 29	K-TB2-4830		\$235.06	\$282.41	
	42 x 30 x 29	K-TB2-4230		\$232.55	\$279.05	
	36 x 30 x 29	K-TB2-3630		\$217.88	\$261.46	
	30 x 30 x 29	K-TB2-3030	High Pressure laminate with equal balanced backer on 1/8" superior grade CARB particle board with 3 mm PVC edging: 4 KAPs, 2 legs, no grommets Includes table connectors		\$209.08	\$250.98
	24 x 30 x 29	K-TB2-2430		\$192.74	\$231.71	
	72 x 24 x 29	K-TB2-7224	High Pressure laminate with equal balanced backer on 1/8" superior grade CARB particle board with 3 mm PVC edging: 4 KAPs, 2 legs, 2 grommets Includes table connectors	\$251.82	\$251.82	\$302.10
	66 x 24 x 29	K-TB2-6624		\$250.56	\$300.42	
	60 x 24 x 29	K-TB2-6024		\$232.55	\$279.05	
	48 x 24 x 29	K-TB2-4824		\$216.20	\$259.36	
	42 x 24 x 29	K-TB2-4224		\$213.27	\$256.01	
	36 x 24 x 29	K-TB2-3624		\$201.54	\$241.76	
	30 x 24 x 29	K-TB2-3024	High Pressure laminate with equal balanced backer on 1/8" superior grade CARB particle board with 3 mm PVC edging: 4 KAPs, 2 legs, no grommets. Includes table connectors		\$192.74	\$231.71
	24 x 24 x 29	K-TB2-2424		\$184.36	\$220.81	
<b>1-LEG TABLE</b>						
(for connecting tables)						
	72 x 30 x 29	K-TB1-7230	High Pressure laminate with equal balanced backer on 1/8" superior grade CARB particle board with 3 mm PVC edging: 4 KAPs, 1 leg, 2 grommets. Includes table connectors	\$268.16	\$268.16	\$319.28
	66 x 30 x 29	K-TB1-6630		\$265.23	\$315.51	
	60 x 30 x 29	K-TB1-6030		\$244.70	\$290.79	
	48 x 30 x 29	K-TB1-4830		\$222.49	\$264.39	
	42 x 30 x 29	K-TB1-4230		\$219.56	\$261.04	
	36 x 30 x 29	K-TB1-3630		\$204.89	\$243.02	
	30 x 30 x 29	K-TB1-3030	High Pressure laminate with equal balanced backer on 1/8" superior grade CARB particle board with 3 mm PVC edging: 4 KAPs, 1 leg, no grommets. Includes table connectors.		\$196.09	\$232.55
	24 x 30 x 29	K-TB1-2430		\$180.17	\$213.27	
	72 x 24 x 29	K-TB1-7224	High Pressure laminate with equal balanced backer on 1/8" superior grade CARB particle board with 3 mm PVC edging: 4 KAPs, 1 leg, 2 grommets. Includes table connectors		\$238.83	\$284.08
	66 x 24 x 29	K-TB1-6624		\$237.57	\$282.41	
	60 x 24 x 29	K-TB1-6024		\$219.98	\$261.04	
	48 x 24 x 29	K-TB1-4824		\$203.22	\$241.34	
	42 x 24 x 29	K-TB1-4224		\$200.28	\$237.99	
	36 x 24 x 29	K-TB1-3624		\$188.55	\$223.75	
	30 x 24 x 29	K-TB1-3024	High Pressure laminate with equal balanced backer on 1/8" superior grade CARB particle board with 3 mm PVC edging: 4 KAPs, 1 leg, no grommets. Includes table connectors		\$180.17	\$213.27
	24 x 24 x 29	K-TB1-2424		\$171.37	\$202.80	

Product	Size L x D x H	Model #	Description	Quick Ship Laminates	Standard Laminates	Dauphin Laminates
<b>NO LEG TABLE</b>						
	72 x 30 x 29	K-TB0-7230	High Pressure laminate with equal balanced backer on 1 <sup>1/8</sup> " superior grade CARB particle board with 3 mm PVC edging: 4 KAPs, no legs, 2 grommets	\$255.17	\$255.17	\$306.29
	66 x 30 x 29	K-TB0-6630		\$252.24	\$252.24	\$302.52
	60 x 30 x 29	K-TB0-6030		\$231.71	\$231.71	\$277.80
	48 x 30 x 29	K-TB0-4830		\$209.50	\$209.50	\$251.40
	42 x 30 x 29	K-TB0-4230		\$206.57	\$206.57	\$248.05
	36 x 30 x 29	K-TB0-3630		\$191.90	\$191.90	\$230.03
	30 x 30 x 29	K-TB0-3030	High Pressure laminate with equal balanced backer on 1 <sup>1/8</sup> " superior grade CARB particle board with 3 mm PVC edging: 4 KAPs, no legs, no grommets		\$183.10	\$219.56
	24 x 30 x 29	K-TB0-2430		\$167.18	\$167.18	\$200.28
	72 x 24 x 29	K-TB0-7224	High Pressure laminate with equal balanced backer on 1 <sup>1/8</sup> " superior grade CARB particle board with 3 mm PVC edging: 4 KAPs, no legs, 2 grommets		\$225.84	\$271.09
	66 x 24 x 29	K-TB0-6624		\$224.58	\$224.58	\$269.42
	60 x 24 x 29	K-TB0-6024		\$206.99	\$206.99	\$248.05
	48 x 24 x 29	K-TB0-4824		\$190.23	\$190.23	\$228.36
	42 x 24 x 29	K-TB0-4224		\$187.29	\$187.29	\$225
	36 x 24 x 29	K-TB0-3624		\$175.56	\$175.56	\$210.76
	30 x 24 x 29	K-TB0-3024	High Pressure laminate with equal balanced backer on 1 <sup>1/8</sup> " superior grade CARB particle board with 3 mm PVC edging: 4 KAPs, no legs, no grommets		\$167.18	\$200.28
	24 x 24 x 29	K-TB0-2424		\$158.38	\$158.38	\$189.81
<b>3 LEG PENNINSULA TABLE</b>						
(for connecting tables)						
	72 x 30 x 29	K-PTB3-7230	High Pressure laminate with equal balanced backer on 1 <sup>1/8</sup> " superior grade CARB particle board with 3 mm PVC edging: 3 KAPs, 3 legs, no grommets Includes table connectors		\$300.84	\$361.18
	60 x 30 x 29	K-PTB3-6030		\$285.76	\$285.76	\$342.74
	72 x 24 x 29	K-PTB3-7224	High Pressure laminate with equal balanced backer on 1 <sup>1/8</sup> " superior grade CARB particle board with 3 mm PVC edging: 3 KAPs, 3 legs, no grommets Includes table connectors		\$282.41	\$338.97
	60 x 24 x 29	K-PTB3-6024		\$274.86	\$274.86	\$329.75
<b>1 LEG PENNINSULA TABLE</b>						
(for connecting tables)						
	72 x 30 x 29	K-PTB1-7230	High Pressure laminate with equal balanced backer on 1 <sup>1/8</sup> " superior grade CARB particle board with 3 mm PVC edging: 3 KAPs, 1 leg, no grommets Includes table connectors		\$268.16	\$321.79
	60 x 30 x 29	K-PTB1-6030		\$253.08	\$253.08	\$303.36
	72 x 24 x 29	K-PTB1-7224	High Pressure laminate with equal balanced backer on 1 <sup>1/8</sup> " superior grade CARB particle board with 3 mm PVC edging: 3 KAPs, 1 leg, no grommets Includes table connectors		\$249.72	\$299.59
	60 x 24 x 29	K-PTB1-6024		\$242.18	\$242.18	\$290.37
<b>L-RETURNS</b>						
	72 x 30 x 29	K-TB2L-7230	High Pressure laminate with equal balanced backer on 1 <sup>1/8</sup> " superior grade CARB particle board with 3 mm PVC edging: 4 KAPs, 2 legs, 2 grommets Includes table connectors	\$274.03	\$274.03	\$328.92
	60 x 30 x 29	K-TB2L-6030		\$250.56	\$250.56	\$300.42
	48 x 30 x 29	K-TB2L-4830		\$228.36	\$228.36	\$274.03
	36 x 30 x 29	K-TB2L-3630		\$210.76	\$210.76	\$253.08
	72 x 24 x 29	K-TB2L-7224	High Pressure laminate with equal balanced backer on 1 <sup>1/8</sup> " superior grade CARB particle board with 3 mm PVC edging: 4 KAPs, 2 legs, 2 grommets Includes table connectors		\$245.12	\$294.14
	60 x 24 x 29	K-TB2L-6024		\$225.84	\$225.84	\$271.09
	48 x 24 x 29	K-TB2L-4824		\$209.08	\$209.08	\$250.98
	36 x 24 x 29	K-TB2L-3624		\$194.42	\$194.42	\$233.38

Product	Size L x L x D x H	Model #	Description	Quick Ship Laminates	Standard Laminates	Dauphin Laminates
<b>5 LEG CORNER TABLE</b>						
	72 x 48 x 24 x 29	K-CTB5-7248LH	High Pressure laminate with equal balanced backer on 1 <sup>1/8</sup> " superior grade CARB particle board with 3 mm PVC edging: 5 KAPs, 5 legs, 3 grommets		\$455.03	\$545.96
	72 x 48 x 24 x 29	K-CTB5-7248RH		\$455.03	\$455.03	\$545.96
	60 x 48 x 24 x 29	K-CTB5-6048LH			\$421.93	\$506.15
	60 x 48 x 24 x 29	K-CTB5-6048RH		\$421.93	\$421.93	\$506.15
	60 x 60 x 24 x 29	K-CTB5-6060			\$494.84	\$593.72
	48 x 48 x 24 x 29	K-CTB5-4848		\$385.32	\$385.32	\$461.32
<b>3 LEG CORNER TABLE</b>						
	72 x 48 x 24 x 29	K-CTB3-7248LH	High Pressure laminate with equal balanced backer on 1 <sup>1/8</sup> " superior grade CARB particle board with 3 mm PVC edging: 5 KAPs, 3 legs, 3 grommets. Includes table connectors.		\$422.35	\$506.57
	72 x 48 x 24 x 29	K-CTB3-7248RH		\$422.35	\$422.35	\$506.57
	60 x 48 x 24 x 29	K-CTB3-6048LH			\$389.25	\$466.77
	60 x 48 x 24 x 29	K-CTB3-6048RH		\$389.25	\$389.25	\$466.77
	60 x 60 x 24 x 29	K-CTB3-6060			\$462.35	\$554.34
	48 x 48 x 24 x 29	K-CTB3-4848		\$352.03	\$352.03	\$422.35
<b>2 LEG CORNER TABLE</b>						
	72 x 48 x 24 x 29	K-CTB2-7248LH	High Pressure laminate with equal balanced backer on 1 <sup>1/8</sup> " superior grade CARB particle board with 3 mm PVC edging: 5 KAPs, 2 legs, 3 grommets. Includes table connectors.		\$407.82	\$488.97
	72 x 48 x 24 x 29	K-CTB2-7248RH		\$407.82	\$407.82	\$488.97
	60 x 48 x 24 x 29	K-CTB2-6048LH			\$449.17	\$449.17
	60 x 48 x 24 x 29	K-CTB2-6048RH		\$449.17	\$449.17	\$449.17
	60 x 60 x 24 x 29	K-CTB2-6060			\$445.16	\$535.48
	48 x 48 x 24 x 29	K-CTB2-4848		\$337.57	\$337.57	\$391.76
<b>1 LEG CORNER TABLE</b>						
	72 x 48 x 24 x 29	K-CTB1-7248LH	High Pressure laminate with equal balanced backer on 1 <sup>1/8</sup> " superior grade CARB particle board with 3 mm PVC edging: 5 KAPs, 1 leg, 3 grommets. Includes table connectors.		\$391.28	\$469.28
	72 x 48 x 24 x 29	K-CTB1-7248RH		\$391.28	\$391.28	\$469.28
	60 x 48 x 24 x 29	K-CTB1-6048LH		\$357.82	\$357.82	\$429.47
	60 x 48 x 24 x 29	K-CTB1-6048RH		\$357.82	\$357.82	\$429.47
	60 x 60 x 24 x 29	K-CTB1-6060		\$429.17	\$429.17	\$514.95
	48 x 48 x 24 x 29	K-CTB1-4848		\$321.64	\$321.64	\$384.64
	30 x 30 x 29	K-CTB1-3030	High Pressure laminate with equal balanced backer on 1 <sup>1/8</sup> " superior grade CARB particle board with 3 mm PVC edging: 5 KAPs, 1 leg, 3 grommets. Includes table connectors.		\$233.73	\$280.73
	24 x 30 x 29	K-CTB1-2430		\$217.46	\$217.46	\$261.46
	24 x 24 x 29	K-CTB1-2424		\$208.28	\$208.28	\$250.98
<b>CORNER LINKS</b>						
	30 x 30 x 36	K-CL90-3030	High Pressure laminate with equal balanced backer on 1 <sup>1/8</sup> " superior grade CARB particle board with 3 mm PVC edging: suspended 90 degree corner link for 30" deep tables		\$177.17	\$212.85
	24 x 24 x 30	K-CL90-2424	High Pressure laminate with equal balanced backer on 1 <sup>1/8</sup> " superior grade CARB particle board with 3 mm PVC edging: suspended 90 degree corner link for 24" deep tables		\$154.85	\$184.36
			Training tables shown with 4 corner links			

Product	Size L x L x D x H	Model #	Description	Quick Ship Laminates	Standard Laminates	Dauphin Laminates
<b>5-LEG 120 TABLES</b>						
	48 x 48 x 24 x 29	K-TB5-120	High Pressure laminate with equal balanced backer on 1/8" superior grade CARB particle board with 3 mm PVC edging: 6 KAPs, 5 legs, 4 grommets		\$496.10	\$595.40
<b>3-LEG 120 TABLES</b>						
	48 x 48 x 24 x 29	K-TB3-120	High Pressure laminate with equal balanced backer on 1/8" superior grade CARB particle board with 3 mm PVC edging: 6 KAPs, 3 leg, 4 grommets		\$463.41	\$556.01
<b>120 TABLES</b>						
		K-TB11-120-P	High Pressure laminate with equal balanced backer on 1/8" superior grade CARB particle board with 3 mm PVC edging: table pod consisting of various table types resulting in a total of 18 KAPs, 11 legs, 12 grommets. Size: 3 of 48 x 48 x 24		\$1443.46	\$1732.15
<b>MODESTY PANELS</b>						
	<b>L x H</b>					
	72 x 15	KMP4-7215	Modesty panel 15" high to be positioned between the front 2 table legs made with matching color and finish.		\$88.41	\$194.42
	66 x 15	KMP4-6615		\$80.03	\$175.98	
	60 x 15	KMP4-6015		\$79.61	\$175.14	
	48 x 15	KMP4-4815		\$70.39	\$154.61	
	42 x 15	KMP4-4215		\$67.46	\$148.33	
	36 x 15	KMP4-3615		\$67.04	\$147.07	
	30 x 15	KMP4-3015		\$65.78	\$144.97	
	24 x 15	KMP4-2415		\$59.92	\$131.57	
	72 x 15	KMP2-7215	Modesty panel 15" high to be positioned between the front table leg and the outside leg of the adjoining table made with matching color and finish.		\$88.41	\$194.42
	66 x 15	KMP2-6615		\$80.03	\$175.98	
	60 x 15	KMP2-6015		\$79.61	\$175.18	
	48 x 15	KMP2-4815		\$70.39	\$154.61	
	42 x 15	KMP2-4215		\$67.46	\$148.33	
	36 x 15	KMP2-3615		\$67.04	\$147.07	
	30 x 15	KMP2-3015		\$65.78	\$144.97	
	24 x 15	KMP2-2415		\$59.92	\$131.57	
	72 x 15	KMP0-7215	Modesty panel 15" high to be positioned between the outside leg of the two adjoining tables made with matching color and finish		\$88.41	\$194.42
	66 x 15	KMP0-6615		\$80.03	\$175.98	
	60 x 15	KMP0-6015		\$79.61	\$175.14	
	48 x 15	KMP0-4815		\$70.39	\$154.61	
	42 x 15	KMP0-4215		\$67.46	\$148.33	
	36 x 15	KMP0-3615		\$67.04	\$147.07	
	30 x 15	KMP0-3015		\$65.78	\$144.97	
	24 x 15	KMP0-2415		\$59.92	\$131.57	

Product	Size L x D x H	Model #	Description	Price
<b>VERTICAL STORAGE UNIT NO SHELVES, NO CRADLES</b>				
	21.25 x 23.5 x 41.5	K-PV1	Locking storage unit in vertical position with roller shutter door supported on a chassis with 4 casters - no storage components	\$491.07
<b>VERTICAL STORAGE UNIT 2 SHELVES</b>				
	21.25 x 23.5 x 41.5	K-PV1S2	Locking storage unit in vertical position with roller shutter door supported on a chassis with 4 casters - 2 vertical shelves	\$581.15
<b>VERTICAL STORAGE UNIT 2 SHELVES, 1 FILING CRADLE</b>				
	21.25 x 23.5 x 41.5	K-PV1S2F1	Locking storage unit in vertical position with roller shutter door supported on a chassis with 4 casters - 2 vertical shelves and 1 vertical filing cradle	\$656.99
<b>VERTICAL STORAGE UNIT 2 SHELVES, 2 FILING CRADLES</b>				
	21.25 x 23.5 x 41.5	K-PV1S2F2	Locking storage unit in vertical position with roller shutter door supported on a chassis with 4 casters - 2 vertical shelves and 2 vertical filing cradles	\$693.86
<b>HORIZONTAL STORAGE UNIT NO SHELVES, NO CRADLE</b>				
	38.5 x 23.5 x 24.5	K-PH1	Locking storage unit in horizontal position with roller shutter door supported on a chassis with 4 casters - no storage components	\$555.17
<b>HORIZONTAL STORAGE UNIT 1 SHELF</b>				
	38.5 x 23.5 x 24.5	K-PH1S	Locking storage unit in horizontal position with roller shutter door supported on a chassis with 4 casters - 1 horizontal shelf	\$633.95
<b>HORIZONTAL STORAGE UNIT 1 SHELF, 1 CRADLE</b>				
	38.5 x 23.5 x 24.5	K-PH1S1F1B1	Locking storage unit in horizontal position with roller shutter door supported on a chassis with 4 casters - 1 horizontal shelf and 1 horizontal filing cradle with personal storage unit	\$685.06
<b>MOBILE PEDESTAL</b>				
	21 x 23.5 x 41.5	K-PED1-BF	Locking mobile drawer pedestal with personal drawer and filing drawer.	\$166.34
<b>STORAGE ACCESSORIES</b>				
		K-PST-SHV1	Vertical Unit Shelf	\$51.54
		K-PST-FCV1	Vertical filing cradle including telescopic runners	\$49.86
		K-PST-SHH1	Horizontal Unit Shelf	\$64.53
		K-PST-FCH1	Horizontal filing cradle with personal storage unit including telescopic runners	\$101.40
		K-PH1-CSHN	Upholstered cushion top with Velcro attachments for horizontal storage unit	\$103.07
		K-PED1-CSHN	Upholstered cushion top with Velcro attachments for mobile drawer pedestal	\$77.51

Product	Size D x W	Model #	Description	Price
<b>24 HIGH TWO POST SCREENS</b>				
	48 x 24	K2-A-4824-1	Acrylic privacy screen 1/4" thick, frosted on both sides, for single table application 24 inches high.	\$161.31
	42 x 24	K2-A-4224-1		\$161.31
	36 x 24	K2-A-3624-1		\$137.01
	30 x 24	K2-A-3024-1		\$128.63
	24 x 24	K2-A-2424-1		\$112.29

<b>24 HIGH THREE POST SCREENS</b>				
	72 x 24	K3-A-7224-1	Acrylic privacy screen 1/4" thick, frosted on both sides, for single table application 24 inches high.	\$225.00
	66 x 24	K3-A-6624-1		\$224.58
	60 x 24	K3-A-6024-1		\$223.33

<b>24 HIGH TWO POST SCREENS</b>				
	48 x 24	K2-A-4824-2	Acrylic privacy screen 1/4" thick, frosted on both sides, for dual table application 24 inches high.	\$163.83
	42 x 24	K2-A-4224-2		\$163.83
	36 x 24	K2-A-3624-2		\$139.53
	30 x 24	K2-A-3024-2		\$131.15
	24 x 24	K2-A-2424-2		\$115.22

<b>24 HIGH THREE POST SCREENS</b>				
	72 x 24	K3-A-7224-2	Acrylic privacy screen 1/4" thick, frosted on both sides, for dual table application 24 inches high.	\$229.19
	66 x 24	K3-A-6624-2		\$228.35
	60 x 24	K3-A-6024-2		\$227.10

Product	Size W x H	Model #	Description	Fabric Grades				
				A	B	C	D	E
<b>TWO POST PANEL-FABRIC-SINGLE SIDE APPLICATION</b>								
	48 x 12	K2-F1-4812-1	System screen, single side application, one upholstered tackable panel, 12 inches high.	\$112.71	\$118.58	\$133.24	\$147.49	\$162.15
	42 x 12	K2-F1-4212-1		\$111.87	\$117.74	\$131.99	\$146.65	\$161.31
	36 x 12	K2-F1-3612-1		\$110.62	\$116.48	\$131.15	\$145.81	\$160.06
	30 x 12	K2-F1-3012-1		\$100.14	\$102.66	\$110.20	\$117.32	\$124.86
	24 x 12	K2-F1-2412-1		\$98.99	\$101.82	\$1785	\$116.48	\$123.60

<b>TWO POST PANEL FABRIC/SLAT-SINGLE SIDE APPLICATION</b>								
	48 x 12	K2-F1S1-4812-1	System screen, single side application, one upholstered tackable panel and one extruded slat wall panel, 12 inches high.	\$137.43	\$140.37	\$147.49	\$154.61	\$162.15
	42 x 12	K2-F1S1-4212-1		\$130.73	\$133.66	\$140.78	\$148.33	\$155.45
	36 x 12	K2-F1S1-3612-1		\$124.02	\$126.96	\$134.08	\$141.62	\$148.74
	30 x 12	K2-F1S1-3012-1		\$109.78	\$111.45	\$114.81	\$118.58	\$122.35
	24 x 12	K2-F1S1-2412-1		\$103.07	\$104.75	\$108.10	\$111.87	\$115.64

<b>THREE POST PANEL-FABRIC-SINGLE SIDE APPLICATION</b>								
	72 x 12	K3-F2-7212-1	System screen, single side application, two upholstered tackable panels, 12 inches high.	\$170.95	\$182.27	\$211.60	\$240.51	\$269.84
	66 x 12	K3-F2-6612-1		\$169.28	\$181.01	\$209.92	\$238.83	\$268.16
	60 x 12	K3-F2-6012-1		\$167.60	\$179.33	\$208.24	\$237.15	\$266.48







<b>THREE POST PANEL-FABRIC/SLAT-SINGLE SIDE APPLICATION</b>								
	72 x 12	K3-F2S2-7212-1	System screen, single side application, two upholstered tackable panels and two extruded slat wall panels, 12 inches high.	\$201.54	\$207.41	\$222.07	\$236.32	\$250.98
	66 x 12	K3-F2S2-6612-1		\$230.45	\$236.32	\$250.98	\$265.65	\$279.89
	60 x 12	K3-F2S2-6012-1		\$199.44	\$204.89	\$219.56	\$234.22	\$248.89

<b>TWO POST PANEL-FABRIC-DOUBLE SIDE APPLICATION</b>								
	48 x 12	K2-F2-4812-2	System screen, dual side application, one upholstered tackable panel each side, 12 inches high.	\$181.01	\$192.74	\$221.65	\$250.56	\$279.89
	42 x 12	K2-F2-4212-2		\$176.82	\$188.13	\$217.46	\$246.37	\$275.70
	36 x 12	K2-F2-3612-2		\$172.63	\$183.94	\$213.27	\$242.18	\$271.51
	30 x 12	K2-F2-3012-2		\$148.33	\$154.19	\$168.86	\$183.52	\$198.19
	24 x 12	K2-F2-2412-2		\$144.14	\$150	\$164.67	\$179.33	\$193.58

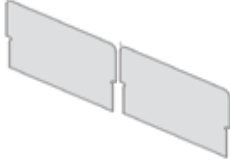
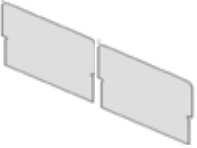
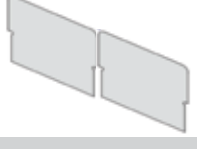





<b>TWO POST PANEL FABRIC/ SLAT-DOUBLE SIDE APPLICATION</b>								
	48 x 12	K2-F2S2-4812-2	System screen, dual side application, one upholstered tackable panel and one extruded slat wall panel each side, 12 inches high.	\$230.03	\$2331	\$250.56	\$265.23	\$279.47
	42 x 12	K2-F2S2-4212-2		\$214.53	\$220.39	\$235.06	\$249.31	\$263.97
	36 x 12	K2-F2S2-3612-2		\$199.03	\$204.89	\$219.14	\$233.80	\$248.47
	30 x 12	K2-F2S2-3012-2		\$168.44	\$171.37	\$178.49	\$185.62	\$193.16
	24 x 12	K2-F2S2-2412-2		\$152.52	\$155.45	\$162.99	\$170.11	\$177.24











<b>THREE POST PANEL-FABRIC-DOUBLE SIDE APPLICATION</b>								
	72 x 12	K3-F4-7212-2	System screen, dual side application, two upholstered tackable panels each side, 12 inches high.	\$306.29	\$329.75	\$387.99	\$446.24	\$504.48
	66 x 12	K3-F4-6612-2		\$301.26	\$324.31	\$382.55	\$440.79	\$499.03
	60 x 12	K3-F4-6012-2		\$296.23	\$319.28	\$377.52	\$435.76	\$494.00

<b>THREE POST PANEL-FABRIC/SLAT-DOUBLE SIDE APPLICATION</b>								
	72 x 12	K3-F4S4-7212-2	System screen, dual side application, two upholstered tackable panels and two extruded slat wall panels each side, 12 inches high.	\$356.15	\$367.46	\$396.79	\$425.70	\$455.03
	66 x 12	K3-F4S4-6612-2		\$339.39	\$351.12	\$380.03	\$409.36	\$438.27
	60 x 12	K3-F4S4-6012-2		\$322.63	\$334.36	\$363.69	\$392.60	\$421.93







Product	Size W x H	Model #	Description	Price
<b>DOUBLE SCREEN APPLICATION-THREE POST SCREEN</b>				
	72 x 24	K-IPA-7224/2	Insert screen - acrylic 1/4" thick, frosted on both sides, shows 12 inches high above system screen. To be used with 72" table (Price is for one screen, can use one or two screens on 72" table)	\$105.59
<b>DOUBLE SCREEN APPLICATION-THREE POST SCREEN</b>				
	66 x 24	K-IPA-6624/2	Insert screen - acrylic 1/4" thick, frosted on both sides, shows 12 inches high above system screen. To be used with 66" table (Price is for one screen, can use one or two screens on 66" table)	\$103.07
<b>DOUBLE SCREEN APPLICATION-THREE POST SCREEN</b>				
	60 x 24	K-IPA-6024/2	Insert screen - acrylic 1/4" thick, frosted on both sides, shows 12 inches high above system screen. To be used with 60" table (Price is for one screen, can use one or two screens on 60" table)	\$96.37
<b>SINGLE SCREEN APPLICATION- TWO POST SCREEN</b>				
	48 x 24	K-IPA-4824	Insert screen - acrylic 1/4" thick, frosted on both sides, shows 12 inches high above system screen. To be used with 48" table.	\$131.15
<b>SINGLE SCREEN APPLICATION-TWO POST SCREEN</b>				
	42 x 24	K-IPA-4224	Insert screen - acrylic 1/4" thick, frosted on both sides, shows 12 inches high above system screen. To be used with 42" table.	\$129.05
<b>SINGLE SCREEN APPLICATION-TWO POST SCREEN</b>				
	36 x 24	K-IPA-3624	Insert screen - acrylic 1/4" thick, frosted on both sides, shows 12 inches high above system screen. To be used with 36" table.	\$97.21
<b>SINGLE SCREEN APPLICATION-TWO POST SCREEN</b>				
	30 x 24	K-IPA-3024	Insert screen - acrylic 1/4" thick, frosted on both sides, shows 12 inches high above system screen. To be used with 30" table.	\$96.37
<b>SINGLE SCREEN APPLICATION -TWO POST SCREEN</b>				
	24 x 24	K-IPA-2424	Insert screen - acrylic 1/4" thick, frosted on both sides, shows 12 inches high above system screen. To be used with 24" table	\$70.39









Product	Size L x D x H	Model #	Description	Quick Ship Laminates	Standard Laminates	Dauphin Laminates	
<b>4 LEG TRAINING TABLE</b>							
	72 x 30 x 29	K-TB4-7230	High Pressure laminate with equal balanced backer on 1/8" superior grade CARB particle board with 3 mm PVC edging: 4 KAPs, 4 legs, 2 grommets	\$306.71	\$306.71	\$368.30	
	66 x 30 x 29	K-TB4-6630		\$303.78	\$364.53		
	60 x 30 x 29	K-TB4-6030		\$283.24	\$339.81		
	48 x 30 x 29	K-TB4-4830		\$261.04	\$312.99		
	42 x 30 x 29	K-TB4-4230		\$258.52	\$310.06		
	36 x 30 x 29	K-TB4-3630	\$243.44	\$292.04			
	30x 30 x 29	K-TB4-3030	High Pressure laminate with equal balanced backer on 1/8" superior grade CARB particle board with 3 mm PVC edging: 4 KAPs, 4 legs, 2 grommets	\$234.64	\$281.57		
	24 x 30 x 29	K-TB4-2430		\$218.72	\$262.29		
		72 x 24 x 29	K-TB4-7224	High Pressure laminate with equal balanced backer on 1/8" superior grade CARB particle board with 3 mm PVC edging: 4 KAPs, 4 legs, 2 grommets	\$265.23	\$277.80	\$333.11
		66 x 24 x 29	K-TB4-6624		\$276.12	\$331.43	
60 x 24 x 29		K-TB4-6024	\$258.52		\$310.06		
48 x 24 x 29		K-TB4-4824	\$241.76		\$290.37		
42 x 24 x 29		K-TB4-4224	\$238.83		\$286.60		
36 x 24 x 29		K-TB4-3624	\$227.10	\$272.77			
30 x 24 x 29		K-TB4-3024	High Pressure laminate with equal balanced backer on 1/8" superior grade CARB particle board with 3 mm PVC edging: 4 KAPs, 4 legs, 2 grommets	\$218.72	\$262.29		
24 x 24 x 29		K-TB4-2424		\$209.92	\$251.82		
<b>4 LEG, 2 CASTERS TRAINING TABLE</b>							
		72 x 30 x 29	K-TB2M-7230	High Pressure laminate with equal balanced backer on 1/8" superior grade CARB particle board with 3 mm PVC edging: 4 KAPs, 4 legs, 2 casters, 2 grommets	\$314.25	\$314.25	\$377.52
	66 x 30 x 29	K-TB2M-6630	\$311.32		\$373.33		
	60 x 30 x 29	K-TB2M-6030	\$268.58		\$348.61		
	48 x 30 x 29	K-TB2M-4830	\$290.79		\$322.21		
	42 x 30 x 29	K-TB2M-4230	\$266.07		\$319.28		
	36 x 30 x 29	K-TB2M-3630	\$250.98	\$301.26			
	30 x 30 x 29	K-TB4-3030	High Pressure laminate with equal balanced backer on 1/8" superior grade CARB particle board with 3 mm PVC edging: 4 KAPs, 4 legs, 2 casters, 2 grommets	\$242.18	\$290.79		
	24 x 30 x 29	K-TB4-2430		\$226.26	\$271.51		
		72 x 24 x 29	K-TB2M-7224	High Pressure laminate with equal balanced backer on 1/8" superior grade CARB particle board with 3 mm PVC edging: 4 KAPs, 4 legs, 2 casters, 2 grommets	\$285.34	\$285.34	\$342.32
		66 x 24 x 29	K-TB2M-6624		\$283.66	\$340.65	
60 x 24 x 29		K-TB2M-6024	\$266.07		\$319.28		
48 x 24 x 29		K-TB2M-4824	\$249.31		\$299.17		
42 x 24 x 29		K-TB2M-4224	\$246.37		\$295.81		
36 x 24 x 29		K-TB2M-3624	\$234.64	\$281.57			
30 x 24 x 29		K-TB2M-3024	High Pressure laminate with equal balanced backer on 1/8" superior grade CARB particle board with 3 mm PVC edging: 4 KAPs, 4 legs, 2 casters, 2 grommets	\$226.26	\$271.51		
24 x 24 x 29		K-TB2M-2424		\$217.46	\$261.04		
<b>4 LEG, 4 CASTERS TRAINING TABLE</b>							
		72 x 30 x 29	K-TB4M-7230	High Pressure laminate with equal balanced backer on 1/8" superior grade CARB particle board with 3 mm PVC edging: 4 KAPs, 4 legs, 4 casters, 2 grommets	\$320.95	\$320.95	\$385.48
	66 x 30 x 29	K-TB4M-6630	\$318.02		\$381.71		
	60 x 30 x 29	K-TB4M-6030	\$297.49		\$356.99		
	48 x 30 x 29	K-TB4M-4830	\$275.28		\$330.17		
	42 x 30 x 29	K-TB4M-4230	\$272.77		\$327.24		
	36 x 30 x 29	K-TB4M-3630	\$257.69	\$309.22			
	30 x 30 x 29	K-TB4M-3030	High Pressure laminate with equal balanced backer on 1/8" superior grade CARB particle board with 3 mm PVC edging :4 KAPs, 4 legs, 4 casters, 2 grommets	\$248.89	\$298.75		
	24 x 30 x 29	K-TB4M-2430		\$232.96	\$279.47		
		60 x 24 x 29	K-TB4M-6024	High Pressure laminate with equal balanced backer on 1/8" superior grade CARB particle board with 3 mm PVC edging: 4 KAPs, 4 legs, 4 casters, 2 grommets	\$292.04	\$292.04	\$350.28
		48 x 24 x 29	K-TB4M-4824		\$290.37	\$348.61	
42 x 24 x 29		K-TB4M-4224	\$272.77		\$327.24		
36 x 24 x 29		K-TB4M-3624	\$256.01		\$307.13		
			\$253.08		\$303.78		
			\$241.34	\$289.53			
30 x 24 x 29		K-TB4M-3024	High Pressure laminate with equal balanced backer on 1/8" superior grade CARB particle board with 3 mm PVC edging: 4 KAPs, 4 legs, 4 casters, 2 grommets	\$232.96	\$279.47		
24 x 24 x 29		K-TB4M-2424		\$224.17	\$269.00		

Product	Size D x L x H	Model #	Description	Quick Ship Laminates	Standard Laminates	Dauphin Laminates
<b>RECTANGULAR 18" DEEP</b>						
	18 x 96 x 29	K-T5R-1896	High Pressure laminate with equal balanced backer on 1/8" superior grade CARB particle board with 3 mm PVC edging: 5 KAPs, 5 legs	\$348.19	\$417.74	
	18 x 84x 29	K-T5R-1884		\$325.14	\$390.09	
	18 x 72x 29	K-T4R-1872	High Pressure laminate with equal balanced backer on 1/8" superior grade CARB particle board with 3 mm PVC edging: 4 KAPs, 4 legs	\$274.03	\$328.92	
	18 x 66 x 29	K-T4R-1866		\$261.04	\$313.41	
	18 x 60 x 29	K-T4R-1860		\$250.98	\$300.84	
	18 x 54 x 29	K-T4R-1854		\$237.99	\$285.34	
	18 x 48 x 29	K-T4R-1848	\$230.03	\$276.12		
<b>RECTANGULAR 24" DEEP</b>						
	24 x 96 x 29	K-T5R-2496	High Pressure laminate with equal balanced backer on 1/8" superior grade CARB particle board with 3 mm PVC edging: 5 KAPs, 5 legs	\$379.20	\$455.03	
	24 x 84 x 29	K-T5R-2484		\$335.20	\$402.24	
	24 x 72 x 29	K-T4R-2472	High Pressure laminate with equal balanced backer on 1/8" superior grade CARB particle board with 3 mm PVC edging: 4 KAPs, 4 legs	\$284.08	\$341.07	
	24 x 66 x 29	K-T4R-2466		\$281.57	\$338.13	
	24 x 60 x 29	K-T4R-2460		\$261.04	\$313.41	
	24 x 54 x 29	K-T4R-2454		\$261.04	\$313.41	
	24 x 48 x 29	K-T4R-2448	\$237.99	\$285.34		
<b>RECTANGULAR 30" DEEP</b>						
	30 x 96 x 29	K-T5R-3096	High Pressure laminate with equal balanced backer on 1/8" superior grade CARB particle board with 3 mm PVC edging: 5 KAPs, 5 legs	\$397.21	\$476.82	
	30 x 84 x 29	K-T5R-3084		\$366.21	\$439.53	
	30 x 72 x 29	K-T4R-3072	High Pressure laminate with equal balanced backer on 1/8" superior grade CARB particle board with 3 mm PVC edging: 4 KAPs, 4 legs	\$310.06	\$372.07	
	30 x 66 x 29	K-T4R-3066		\$307.55	\$369.14	
	30 x 60 x 29	K-T4R-3060		\$284.08	\$341.07	
	30 x 54 x 29	K-T4R-3054		\$284.08	\$341.07	
	30 x 48 x 29	K-T4R-3048	\$258.52	\$310.06		
<b>RECTANGULAR 36" DEEP</b>						
	36 x 96 x 29	K-T5R-3096	High Pressure laminate with equal balanced backer on 1/8" superior grade CARB particle board with 3 mm PVC edging: 5 KAPs, 5 legs	\$443.72	\$532.12	
	36 x 84 x 29	K-T5R-3084		\$428.22	\$513.69	
	36 x 72 x 29	K-T4R-3672	High Pressure laminate with equal balanced backer on 1/8" superior grade CARB particle board with 3 mm PVC edging: 4 KAPs, 4 legs	\$364.11	\$437.02	
	36 x 66 x 29	K-T4R-3666		\$343.58	\$412.30	
	36 x 60 x 29	K-T4R-3660		\$310.06	\$372.07	
	36 x 54 x 29	K-T4R-3654		\$310.06	\$372.07	
	36 x 48 x 29	K-T4R-3648	\$284.08	\$341.07		
<b>RECTANGULAR 42" DEEP</b>						
	42x 96 x 29	K-T5R-4296	High Pressure laminate with equal balanced backer on 1/8" superior grade CARB particle board with 3 mm PVC edging: 5 KAPs, 5 legs	\$541.35	\$649.87	
	42x 84 x 29	K-T5R-4284		\$513.28	\$616.93	
	42 x 72 x 29	K-T4R-4272	High Pressure laminate with equal balanced backer on 1/8" superior grade CARB particle board with 3 mm PVC edging: 4 KAPs, 4 legs	\$418.16	\$501.96	
	42 x 66 x 29	K-T4R-4266		\$402.66	\$483.54	
	42 x 60 x 29	K-T4R-4260		\$377.10	\$452.52	
	42 x 54 x 29	K-T4R-4254		\$377.10	\$452.52	
	42 x 48 x 29	K-T4R-4248	\$343.58	\$412.30		



Product	Size D x L x H	Model #	Description	Quick Ship	Standard	Dauphin
				konstrux Laminates	konstrux Laminates	Dauphin Laminates
<b>ROUND</b>						
	48 Diameter x 29	K-T4C-48	High Pressure laminate with equal balanced backer on 1/8" superior grade CARB particle board with 3 mm PVC edging: freestanding table with 4 KAPs, 4 legs		\$323.05	\$387.58
	42 Diameter x 29	K-T4C-42		\$323.05	\$387.58	
	36 Diameter x 29	K-T4C-36		\$258.52	\$310.06	
	30 Diameter x 29	K-T4C-30		\$230.03	\$276.12	
<b>SQUARE</b>						
	48 x 48 x 29	K-T4R-4848	High Pressure laminate with equal balanced backer on 1/8" superior grade CARB particle board with 3 mm PVC edging: 4 KAPs, 4 legs		\$343.58	\$412.30
	42 x 42 x 29	K-T4R-4242		\$343.58	\$412.30	
	36 x 36 x 29	K-T4R-3636		\$250.98	\$300.84	
	48 x 48 x 29	K-T2R-4848	High Pressure laminate with equal balanced backer on 1/8" superior grade CARB particle board with 3 mm PVC edging: 4 KAPs, 2 legs		\$310.90	\$372.91
	42 x 42 x 29	K-T2R-4242		\$310.90	\$372.91	
	36 x 36 x 29	K-T2R-3636		\$217.88	\$261.46	
<b>RACE TRACK SHAPED</b>						
	72 x 42 x 29	K-T3D-7242	High Pressure laminate with equal balanced backer on 1/8" superior grade CARB particle board with 3 mm PVC edging: 3 KAPs, 3 legs Includes table connectors		\$356.99	\$428.22
	66 x 36 x 29	K-T3D-6636		\$284.92	\$341.90	
	48 x 30 x 29	K-T3D-4830		\$233.38	\$279.89	
	42 x 27 x 29	K-T3D-4227		\$209.92	\$252.24	
	36 x 24 x 29	K-T3D-3624		\$186.46	\$242.60	
	30 x 21 x 29	K-T3D-3021		\$184.36	\$221.23	
	72 x 42 x 29	K-T1D-7242	High Pressure laminate with equal balanced backer on 1/8" superior grade CARB particle board with 3 mm PVC edging: 3 KAPs, 1 leg Includes table connectors		\$324.31	\$388.83
	66 x 36 x 29	K-T1D-6636		\$251.82	\$302.52	
	48 x 30 x 29	K-T1D-4830		\$200.28	\$240.51	
	42 x 27 x 29	K-T1D-4227		\$179.75	\$215.79	
	36 x 24 x 29	K-T1D-3624		\$172.21	\$206.57	
	30 x 21 x 29	K-T1D-3021		\$186.46	\$184.78	
<b>BULLET SHAPED</b>						
	48 x 60 x 29	K-T4B-4860	High Pressure laminate with equal balanced backer on 1/8" superior grade CARB particle board with 3 mm PVC edging: 4 KAPs, 4 legs Includes table connectors		\$372.07	\$446.24
	48 x 48 x 29	K-T4B-4848		\$323.05	\$387.58	
	42 x 60 x 29	K-T4B-4260		\$372.07	\$446.24	
	42 x 48 x 29	K-T4B-4248		\$323.05	\$387.58	
	48 x 60 x 29	K-T2B-4860	High Pressure laminate with equal balanced backer on 1/8" superior grade CARB particle board with 3 mm PVC edging: 4 KAPs, 2 legs Includes table connectors		\$206.99	\$406.85
	48 x 48 x 29	K-T2B-4848		\$188.97	\$348.19	
	42 x 60 x 29	K-T2B-4260		\$320.12	\$406.85	
	42 x 48 x 29	K-T2B-4248		\$186.46	\$348.19	

Product	Size L x D	Model #	Description	Quick Ship	Standard	Dauphin
				Laminates	Laminates	Laminates
<b>EXTEND-A-LEAF 72" WIDE</b>						
	72 x 48	K-TORL-7248	High Pressure laminate with equal balanced backer on 1/8" superior grade CARB particle board with 3 mm PVC edging: 4 KAPs no legs Includes table connectors		\$223.33	\$446.23
	72 x 42	K-TORL-7242		\$371.65	\$430.73	
	72 x 36	K-TORL-7236		\$359.08	\$399.73	
<b>EXTEND-A-LEAF 60" WIDE</b>						
	60 x 48	K-TORL-6048	High Pressure laminate with equal balanced backer on 1/8" superior grade CARB particle board with 3 mm PVC edging: 4 KAPs no legs Includes table connectors		\$333.11	\$384.22
	60 x 42	K-TORL-6042		\$320.12	\$384.22	
	60 x 36	K-TORL-6036		\$320.12	\$310.06	
	60 x 30	K-TORL-6030		\$258.52	\$279.05	
	60 x 24	K-TORL-6024		\$232.55	\$251.40	
<b>EXTEND-A-LEAF 48" WIDE</b>						
	48 x 60	K-TORL-6048	High Pressure laminate with equal balanced backer on 1/8" superior grade CARB particle board with 3 mm PVC edging: 4 KAPs no legs Includes table connectors		\$320.12	\$384.22
	48 x 54	K-TORL-4854		\$320.12	\$384.22	
	48 x 48	K-TORL-4848		\$292.04	\$350.22	
	48 x 42	K-TORL-4842		\$292.04	\$350.28	
	48 x 36	K-TORL-4836		\$232.55	\$279.05	
	48 x 30	K-TORL-4830		\$206.99	\$248.46	
	48 x 24	K-TORL-4824		\$188.971	\$226.67	
<b>EXTEND-A-LEAF 42" WIDE</b>						
	42 x 60	K-TORL-6042	High Pressure laminate with equal balanced backer on 1/8" superior grade CARB particle board with 3 mm PVC edging: 4 KAPs no legs Includes table connectors		\$320.12	\$917
	42 x 54	K-TORL-4254		\$320.12	\$917	
	42 x 48	K-TORL-4248		\$292.04	\$836	
	42 x 42	K-TORL-4242		\$292.04	\$836	
	42 x 36	K-TORL-4236		\$214.53	\$615	
	42 x 30	K-TORL-4230		\$204.47	\$585	
	42 x 24	K-TORL-4224		\$186.46	\$533	
<b>EXTEND-A-LEAF 36" WIDE</b>						
	36 x 60	K-TORL-6036	High Pressure laminate with equal balanced backer on 1/8" superior grade CARB particle board with 3 mm PVC edging: 4 KAPs no legs Includes table connectors		\$320.12	\$310.06
	36 x 54	K-TORL-3654		\$320.12	\$310.06	
	36 x 48	K-TORL-4836		\$292.04	\$279.05	
	36 x 42	K-TORL-4236		\$292.04	\$257.68	
	36 x 36	K-TORL-3636		\$232.55	\$257.06	
	36 x 30	K-TORL-3630		\$206.99	\$245.11	
	36 x 24	K-TORL-3624		\$188.97	\$245.11 \$223.32	
<b>EXTEND-A-LEAF 30" WIDE</b>						
	30 x 60	K-TORL-6030	High Pressure laminate with equal balanced backer on 1/8" superior grade CARB particle board with 3 mm PVC edging: 4 KAPs no legs Includes table connectors		\$320.12	\$279.05
	30 x 54	K-TORL-3054		\$320.12	\$279.05	
	30 x 48	K-TORL-4830		\$292.04	\$284.46	
	30 x 42	K-TORL-4230		\$292.04	\$445.11	
	30 x 36	K-TORL-3630		\$232.55	\$445.11	
	30 x 30	K-TORL-3030		\$206.99	\$245.11	
30 x 24	K-TORL-3024	\$188.97	\$223.32			

konstrux offers a system which is easily assembled and re-configured thereby allowing the user to keep their working, conference and training environment relevant to their specific task. While power is not fitted standard on the conference tables, konstrux offers flexible power and data capabilities from working across to training and conference.

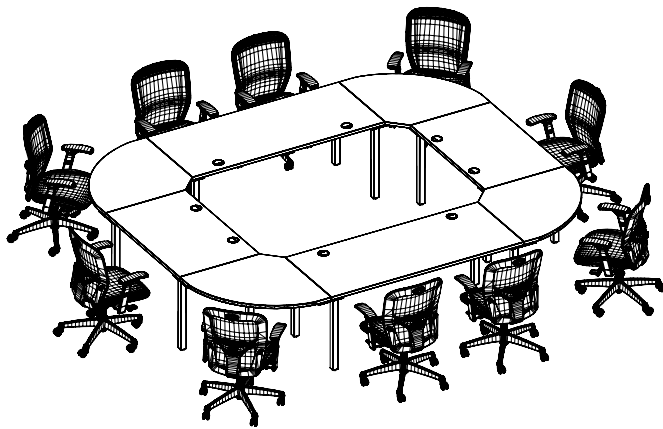

A round configuration for promoting discussion and interchanging of ideas





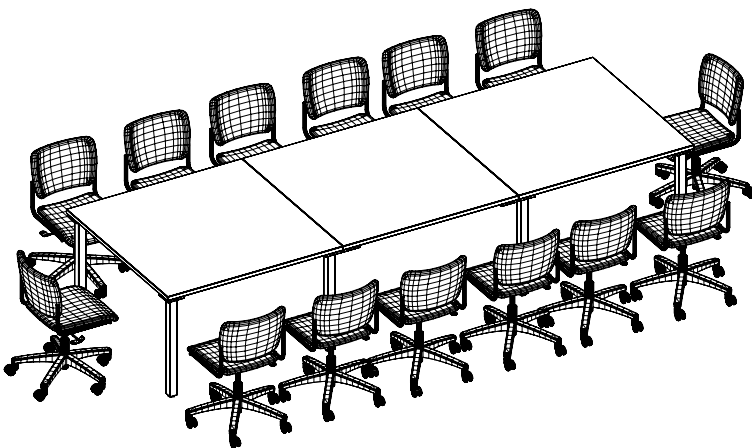







konstrux offers a system which is easily assembled and re-configured thereby allowing the user to keep their working, conference and training environment relevant to their specific task. While power is not fitted standard on the conference tables, konstrux offers flexible power and data capabilities from working across to training and conference.



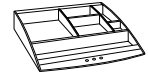
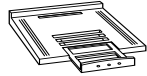
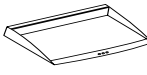





A rectangular table with inserted extend-a-leaf ensures maximum space utilization of a typical rectangular room











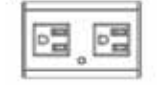



A racetrack table with 2 standard end tables allows for more seating than a simple round table and allows for expansion should it be needed.



Product	Model #	Description	Price
KONCEPT LIGHT			
	K-KON1-400*	Koncept Light	\$152.52
KONCEPT MINI LIGHT			
	K-KONMINI1-400*	Koncept Mini Light	\$130.73
KONCEPT LIGHT DESK CLAMP			
	K-KONCLMP1	Koncept Light Desk Clamp Koncept Mini Light Desk Clamp	\$16.34
KONCEPT MINI LIGHT SLAT WALL CONNECTOR			
	K-KONSLAT1-BR	Koncept Mini Light Slat Wall Connector	\$16.34
ACCESSORY TRAY			
	K-CPF-1204PDA	Accessory Tray, Indv. Box, Clear	\$15.08
PHONE SUPPORT			
	K-CPF-1205PDA	Phone Support, Indv. Box, Clear	\$16.34
PAPER TRAY			
	K-CPF-1203PDA	Letter Paper Tray, holds paper size 8.5" x 10"	\$18.86
	K-CPF-1207PDA	Legal Paper Tray, holds paper size 8.5" x 14"	\$20.53
FOLDER SORTER			
	K-CPF-1208PDA	Folder Sorter Tray, Indv. Box, Clear	\$21.79
BINDER HOLDER			
	K-CPF-1209PDA	Binder Holder, Indv. Box, Clear	\$13.83
CUP HOLDER			
	K-CPF-12014PDA	Cup Holder	\$9.64
PENCIL HOLDER			
	K-CPF-1200PDA	Pencil Holder	\$9.64
CD HOLDER			
	K-CPF-1201PDA	CD Holder	\$13.83
ACCESSORY TRAY			
	K-CPF-1203PDA	Accessory Tray	\$18.86

All Items: SIN 711-2 \* Open Market Item

Product	Model #	Description	Standard Laminates	Dauphin Laminates
<b>SCREEN SHELF INCLUDING BRACKETS</b>				
	K-ACSH-4806	Screen shelf with pencil groove, MDF powder coat silver mounting brackets, 6" deep	\$43.58	\$52.38
	K-ACSH-3606		\$42.74	\$50.28
	K-ACSH-3006		\$41.48	\$49.02
<b>TRANSACTION SHELF INCLUDING BRACKETS</b>				
	K-TT-7212	Transaction shelf, Laminate color to match table with mounting brackets, 12" deep	\$87.57	\$105.17
	K-TT-6012		\$71.23	\$85.48
	K-TT-4812		\$67.04	\$80.45
<b>•ADDITIONAL CONNECTORS FOR RECONFIGURATION</b>				
<b>TABLE TO TABLE CONNECTOR-NO SCREEN</b>				
	K-WS-TIE1SET	Table to table connector connect 2 tables together through the KAP. This could eliminate the need for a leg.	<b>Price</b>	
			\$3.35	
<b>SCREEN TABLE CONNECTOR WITH SINGLE SIDE APPLICATION SCREEN</b>				
	K-SCLG-TIE1SET	Screen table connector with single side application screen connects the screen leg to the KAP.	<b>Price</b>	
			\$4.19	
<b>DOUBLE TABLE TO TABLE CONNECTOR WITH SCREEN, DOUBLE SIDE APPLICATION SCREEN</b>				
	K-SCLG-TIE2SET	Double table to table connector with dual side application screen connects the screen leg to the KAP as well as connecting 2 tables together through the KAP. This could eliminate the need for a leg.	<b>Price</b>	
			\$4.19	
<b>L CONNECTOR SET</b>				
	K-LRET-TIE	Connector set enables the connection of a top with a KAP to connect to another top where there is no KAP to allow for the connection.	<b>Price</b>	
			\$3.77	

Product	Model #	Description	Price
<b>POWER UNIT- SECLUSION</b>			
	K-DL-2	Silver unit with mounting bracket, 2 power receptacles, no data, 12" daisy link whip and daisy T power manager.	\$182.27
	K-DL-3	Silver unit with mounting bracket, 3 power receptacles, no data, 12" daisy link whip and daisy T power manager.	\$191.90
	K-DL-4	Silver unit with mounting bracket, 4 power receptacles, no data, 12" daisy link whip and daisy T power manager.	\$211.18
	K-DL-1B	Silver unit with mounting bracket, 1 power receptacle, 1 data port, 12" daisy link whip and daisy T power manager.	\$182.27
	K-DL-2AB	Silver unit with mounting bracket, 2 power receptacles, 1 data and 1 voice ports, 12" daisy link whip and daisy T power manager.	\$215.79
	K-DL-3AB	Silver unit with mounting bracket, 3 power receptacles, 1 telecom plate with 1 data and 1 voice ports, 12" daisy link whip and daisy T power manager.	\$268.16
	K-DL-4AB	Silver unit with mounting bracket, 4 power receptacles, 1 telecom plate with 1 data and 1 voice ports, 12" daisy link whip and daisy T power manager.	\$277.80
<b>POWER UNIT-VILLA</b>			
	K-VL-2BB	Villa silver power base including 2 power receptacles, 2 data ports. Must specify location of cut out when ordering.	\$117.32
	K-VL-2	Villa silver power base including 2 power receptacles and 2 data openings. Must specify location of cut out when ordering.	\$69.14
	K-VL-FG	Villa grommet for power base - flush style with cutout finger grip. Must specify location of cut out when ordering.	\$39.81
	K-VL-LG	Villa grommet for power base - lift style with raised finger grip. Must specify location of cut out when ordering.	\$39.81

Product	Model #	Description	Price
<b>INTERCONNECTING CABLES</b>			
	K-DLCC-72	Interconnecting cable with molded connector plug at either end of cable - 68" for a 72" table	\$48.15
	K-DLCC-66	Interconnecting cable with molded connector plug at either end of cable - 62" for 66" table	\$45.25
	K-DLCC-60	Interconnecting cable with molded connector plug at either end of cable - 56" for 60" table	\$42.73
	K-DLCC-48	Interconnecting cable with molded connector plug at either end of cable - 44" for 48" table	\$38.12
	K-DLCC-42	Interconnecting cable with molded connector plug at either end of cable - 38" for 42" table	\$36.03
	K-DLCC-36	Interconnecting cable with molded connector plug at either end of cable - 32" for 36" table	\$33.52
	K-DLCC-30	Interconnecting cable with molded connector plug at either end of cable - 26" for 30" table	\$33.52
	K-DLCC-24	Interconnecting cable with molded connector plug at either end of cable - 20" for 24" table	\$33.52

Product	Model #	Description	Price
<b>POWER FEEDS</b>			
	K-DLPP-144	Hardwire starting cable with molded female connector plug at one end - 144"	\$76.67
	K-DLPP-108	Hardwire starting cable with molded female connector plug at one end - 108"	\$62.43
	K-DLPP-72	Hardwire starting cable with molded female connector plug at one end - 72"	\$49.02
	K-DLPP-72-3P	Plug In starting cable with molded 3 pin plug at one end and a molded female connector plug on the other end - 72"	\$74.16



Product	Model #	Description	Price
<b>FLOOR TO DESK POWER POLE</b>			
	K-FTD-29	Floor to desk power pole with lower leg connector and KAP connector	\$153.77

Product	Model #	Description	Price
<b>FLOOR TO CEILING POWER POLE</b>			
	K-FTC-180	Floor to ceiling power pole with lower leg connector and KAP connector - cut out for power to exit to underside of table	Price on request

Size L x D x H	Model #	Description	Standard Laminates
<b>NESTING TABLE</b>			
	60 x 20 x 29 K-TBF-6020	Mobile flip top nesting table, with two lever-lock heavy-duty casters. HPL worksurface on .75" thick superior grade C.A.R.B. compliant particle board with balanced HPL backer with ABS edging. Fully supported by metal frame. Shipped KD.	\$387.57
	60 x 24 x 29 K-TBF-6024		<b>\$387.57 Quick Ship*</b>
	60 x 30 x 29 K-TBF-6030		\$416.90
	72 x 20 x 29 K-TBF-7220		\$458.80
	72 x 24 x 29 K-TBF-7224		\$458.80
	72 x 30 x 29 K-TBF-7230		\$488.13

\*Quick Ship: for more than 20 tables verify delivery with Customer Service.

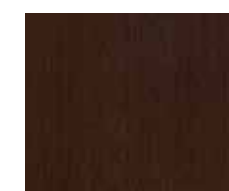
Product	Model #	Description	Price
<b>ACCESSORIES</b>			
	K-MPF-6012 200	Modesty Panel for 60" and 72" length tables	\$37.71
	K-WBF-6030	Accessory Basket for 60" and 72" length tables	\$29.33
	Ganging Connectors	Ganging Connectors	\$29.33 per table
	Cut Outs and Grommets	Available on 24" deep and 30" deep tops.	
		Two 3" round grommets - 1 on left & 1 on right	\$29.33 <small>For quantities more than 20 tables, \$12.57 per cut out/grommet</small>
		One 3" round grommet - Center	\$20.95 <small>For quantities more than 20 tables, \$8.38 per cut out/grommet</small>
		One 3" x 5" rectangle grommet - Center	\$20.95 <small>For quantities more than 20 tables, \$8.38 per cut out/grommet</small>
	Electrical accessories	See Valo konstrux Tables Price List on <a href="http://www.valofurniture.com">www.valofurniture.com</a> For more detailed information, contact Customer Service.	

Finish	Color
Bio Bamboo	
Designer White	
Fusion Maple	

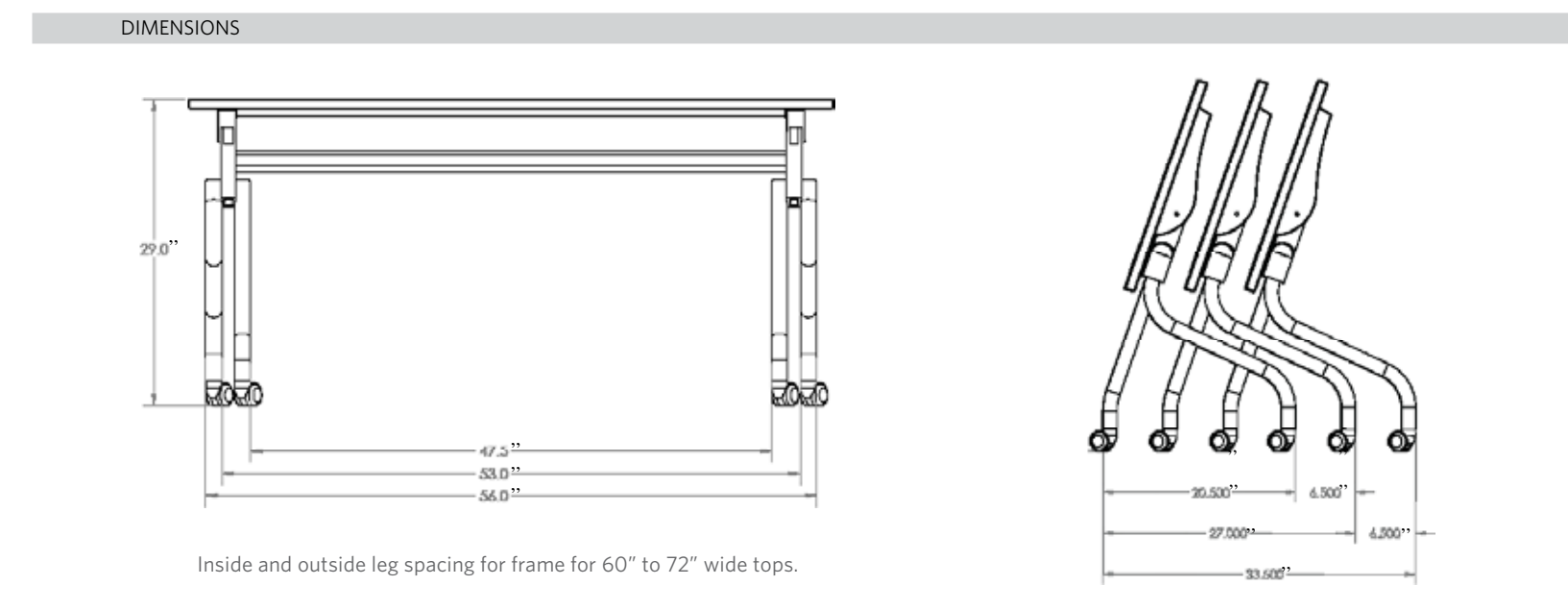

KONSTRUX STANDARD LAMINATE

All Items: SIN 711-2



FUSION MAPLE  
Quick Ship available in certain sizes



DESIGNER WHITE  
Quick Ship available in certain sizes



BIO BAMBOO

METAL COMPONENTS AND LEG COLOR

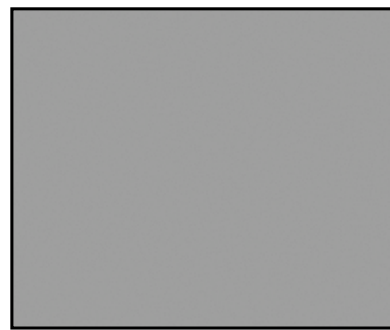

SILVER

SCREEN SUPPORT COLOR

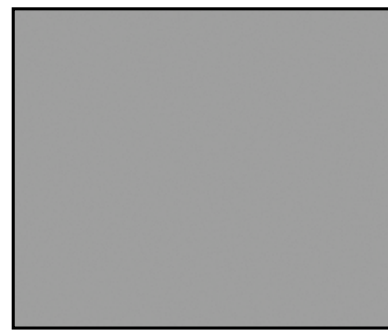

SILVER

SCREEN FABRICS

Grade A  
Equal Panel Fabric



EQ538 SILVER PAPIERE  
QUICK SHIP



EQ130 WHEAT  
QUICK SHIP



EQ758 DESERT SAND



EQ481 PEARL

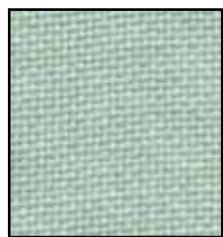

EQ468 EUCALYPTUS



EQ401 BLUE NEUTRAL

Grade B  
Whirlwind Panel Fabric



154-016 STERLING



154-013 WASABI



154-009 TAWNY



154-007 BEACH



154-003 PISTACHIO



154-002 SUNBEAM

KONSTRUX

All Items: SIN 711-2

DAUPHIN LAMINATE



L444  
Chocolate Pear Tree



L420 Summer Flame



512 Bio Bamboo



687 Bryan Maple



912 Storm

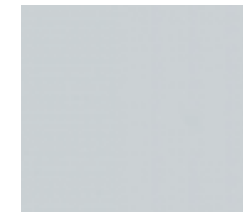

168 Canadian Grey

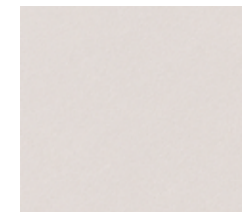

805 Sunset Grey



807 Calamare



7022  
Natural Canvas

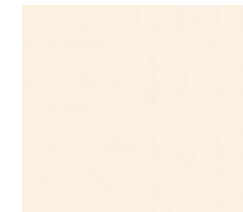

810 Antique White



888 Black

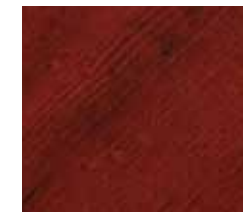

765 Port Maple



978 Regal Cherry



555 Nova White



992  
Hard Rock Maple



802 Willow Grey



702 Crystal Sandstorm



961 Stainless

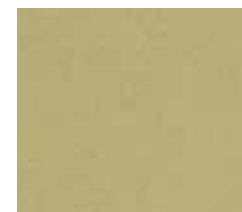

947 Optical Kiwi



4142 Grey Glace



L421 Candlelight



7215  
Earthen Terra



971 Pear



745 Finesse

